

LEISTER®

English

UNIPLAN 300 / 500

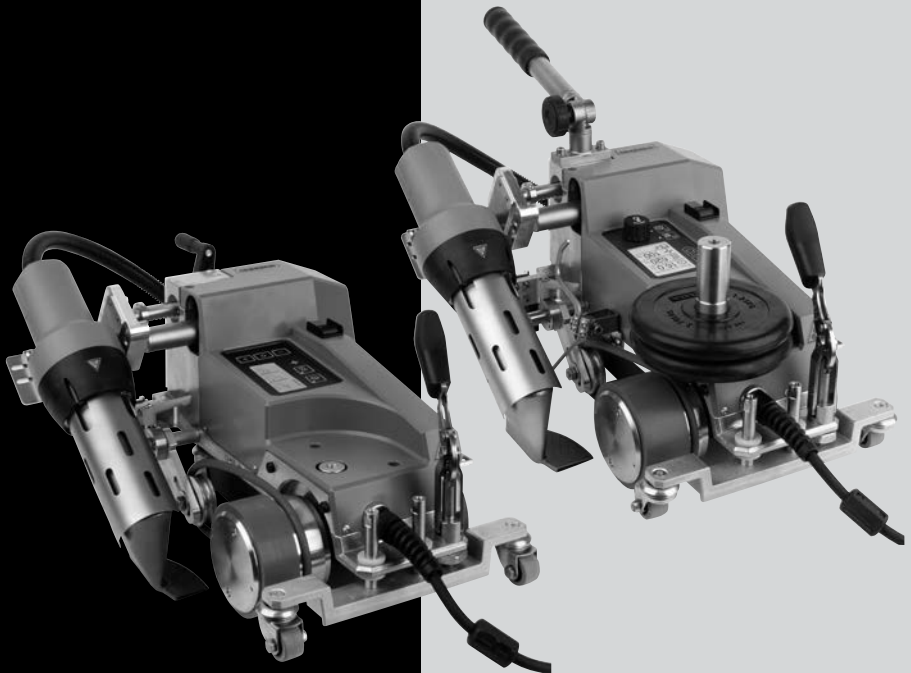

Leister Technologies AG
Galileo-Strasse 10
CH-6056 Kaegiswil/Switzerland
Tel. +41 41 662 74 74
Fax +41 41 662 74 16
www.leister.com
sales@leister.com

Contents

1. Application	4
1.1 Intended use	4
1.2 Improper use	4
1.3 Safety Instructions	4
1.4 Power supply	4
2. Technical data	5
3. Transporting	5
4. Your UNIPLAN 300 / 500	6
4.1 Specification plate and identification	6
4.2 Scope of delivery (standard equipment in the case)	6
4.3 Overview of device parts	7
4.4 Power supply interruption	8
5. UNIPLAN 500 control panel	8
5.1 Overview of the UNIPLAN 500 control panel	8
5.2 Function keys	8
5.3 LED status display	9
5.4 Display symbols for the UNIPLAN 500 status display	10
5.5 Display symbols of the function display	10
5.6 Display symbols for the UNIPLAN 500 working display	10
5.7 Display symbols of the menu selection (Display 42)	12
6. Setup menu on the UNIPLAN 500 control panel	12
6.1 Setting up, saving, and selecting recipes (Save Recipes)	12
6.2 Entering recipe names	13
6.3 Basic setting and Advanced Mode	14
6.4 Operating readiness (Eco Mode)	14
6.5 Duty Info (only in Advanced Mode)	15
6.6 General Info (only in Advanced Mode)	15
6.7 Warnings (only in Advanced Mode)	15
6.8 Machine Setup (only in Advanced Mode)	15
6.9 Displaying current values – Application Mode (only in Advanced Mode)	16
6.10 Set Values (only in Advanced Mode)	16
6.11 Reset to defaults (only in Advanced Mode)	16
6.12 Day distance display	16
6.13 Key lock	17
7. Commissioning the UNIPLAN 500	17
7.1 Operating readiness	17
7.2 Starting the device	19
7.3 Setting the welding parameters	19
7.4 Welding sequence	20
7.5 Welding completion	21
7.6 Turning off the device	21

8. Warning and error messages (UNIPLAN 500)	22
9. UNIPLAN 300 control panel	23
9.1 Overview of the UNIPLAN 500 control panel	23
9.2 Symbols	23
9.3 LED status display	23
9.4 Setting the parameter units	24
10. Commissioning the UNIPLAN 300	25
10.1 Operating readiness	25
10.2 Starting the device	25
10.3 Setting the welding parameters	25
10.4 Welding sequence	26
10.5 Finishing welding	27
10.6 Turning off the device	27
11. Warning and error messages, UNIPLAN 300	28
12. Maintenance of the UNIPLAN 300	28
13. Frequently asked questions	29
14. Other applicable documents	29
15. Declaration of Conformity	30

Congratulations on your purchase of the UNIPLAN 300 / 500.

You have chosen a first-class hot-air welder.

It was developed and produced in accordance with the very latest state of technology in the plastics-processing industry.

It has also been manufactured using high-quality materials.



We recommend that you always keep the operating instructions with the device.

UNIPLAN 300 / 500 hot-air welder



You can find more information on the UNIPLAN 300 / 500 at www.leister.com

Application

Intended use

- Manually-guided hot-air welder for overlap welding, hem welding or pipe welding PVC, PE and similar materials.
- For use in well-ventilated areas.
- Welding widths: 20mm, 30mm and 40mm

The statutory health and safety regulations applicable in the country of use must be complied with. Never use the hot-air welder in explosive or readily flammable surroundings. Maintain sufficient distance from combustible materials or explosive gases at all times.

Read the material safety data sheet from the material manufacturer and follow their instructions. Be careful not to burn the material during the welding process.

Improper use

Any other use of the UNIPLAN 300 / 500 or any use beyond the type of use described is deemed improper use.

Safety Instructions

The safety instructions for the device can be found in the section on "Safety Instructions – Automatic Welders/Extrusion Welders/Welding Machines" in the document provided.

You can also find this document in the operating instructions on our website.

Power supply

Power cord and extension cable

- The **power cord (3)** must be able to move freely and must not hinder the user or third parties during work (trip hazard).
- Any extension cables must be approved for the utilization site and be marked accordingly. Take into account the necessary minimum conductor cross-section for extension cables, as required.









230 V ~	up to	50 m	3 x 1.5 mm²
		100 m	3 x 2.5 mm²
120 V ~	up to	50 m	3 x 1.5 mm²
	up to	100 m	3 x 2.5 mm²

On-site generators for power supply

When using on-site generators as a power supply, please ensure that the on-site generators are grounded and equipped with residual-current circuit breakers.

For the nominal output of on-site generators, the formula "2 × nominal output of the hot-air welder applies".

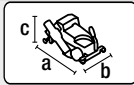
Technical data

		UNIPLAN 300		UNIPLAN 500	
	V~	120	230	120	230
	Hz	50 / 60			
	W	1800	3450	1800	3450
	°C	100 – 550		100 – 620	
	°F	212 – 1022		212 – 1148	
	m/min	1 – 16			
	ft/min	3.3 – 52.5			
	mm	20 / 30 / 40			
	inch	0.8 / 1.2 / 1.6			
	rpm	8'800	12'500	12'600	18'000
		brushed		brushless	
	L _{PA} (dB)	70 (K = 3)			
	kg	15		16	
	lbs	33		35	
	a) mm / inch	500 / 19.7			
	b) mm / inch	310 / 12.2			
	c) mm / inch	300 / 11.8			
		 			

* without **auxiliary weight (15)** and **power cord (3)**

We reserve the right to make technical changes.

Transporting

Comply with applicable, national regulations regarding the carrying or lifting of loads. For transporting the hot-air welder use only the transport box included in the scope of delivery and carry the transport box using the handle.



The **hot-air blower (9)** reaches temperatures of 650°C. Therefore, take great care and allow the **hot-air blower (9)** to cool down sufficiently before packing and transporting it (see Cool-Down Mode). There is a risk of burns and of fire.



Never store flammable materials (such as plastic or wood) in the transport box. There is a risk of fire.



Never use the **carrying handle (1)** on the device or on the transport box for transporting it with a crane.

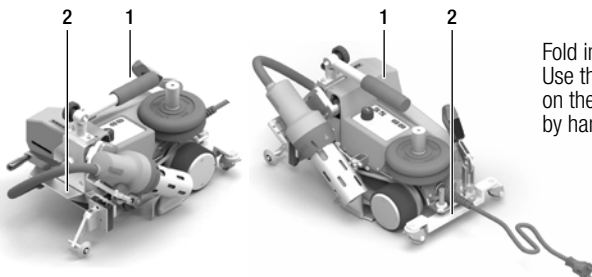

Fold in the **hot-air blower (9)** prior to transport. Use the **carrying handle (1)** or the **handles (2)** on the aluminum housing to lift the hot-air welder by hand.

Your UNIPLAN 300 / 500

Specification plate and identification

The model and serial number are indicated on your device's **specification plate (21)**.

Please write this information on your operating instructions. In the event of any inquiries to our representatives or authorized Leister Service Centers, please always refer to this information.

Model:.....
Serial no:.....

Example:



Scope of delivery (standard equipment in the case)

UNIPLAN 300

- 1 x UNIPLAN 300
- 1 x **Overlap guide (18)**
- 1 x Safety instructions
- 1 x Quick guide
- 1 x Main catalog

UNIPLAN 500

- 1 x UNIPLAN 500
- 1 x **Carrying handle / guide handle, short (1)**
- 2 x **Weights:1.25 kg each (15)**
- 1 x **Overlap guide (18)**
- 1 x **Material lifting device (19)**
- 1 x **Lever screw (20)**
- 1 x **Bracket for guide handle (21)**
- 1 x **Weight holder base (22)**
- 1 x **Weight holder extension (23)**
- 1 x **Nozzle adjustment gauge (24)**
- 1 x **Brass wire bush (25)**
- 1 x Safety instructions
- 1 x Quick guide
- 1 x Main catalog
- 1 x **Hem guide (45)**

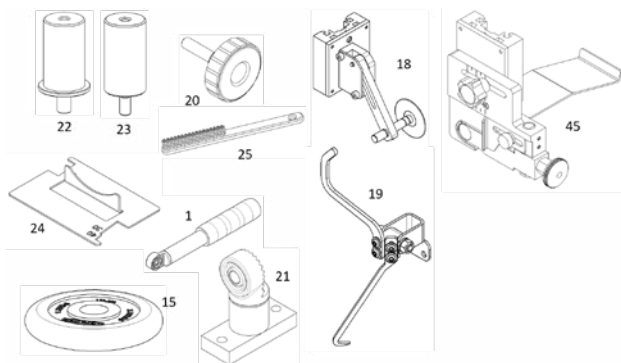

Overview of device parts

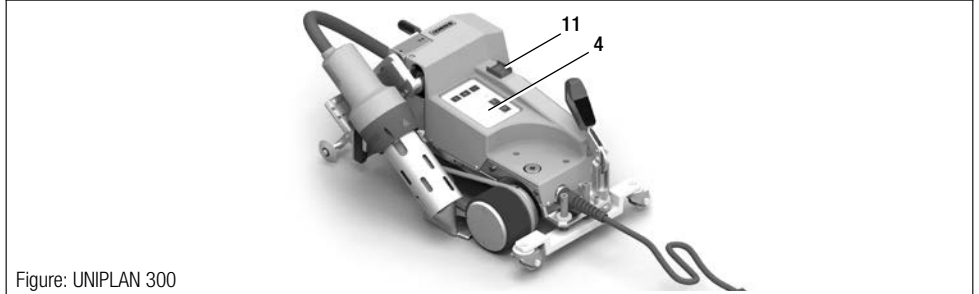
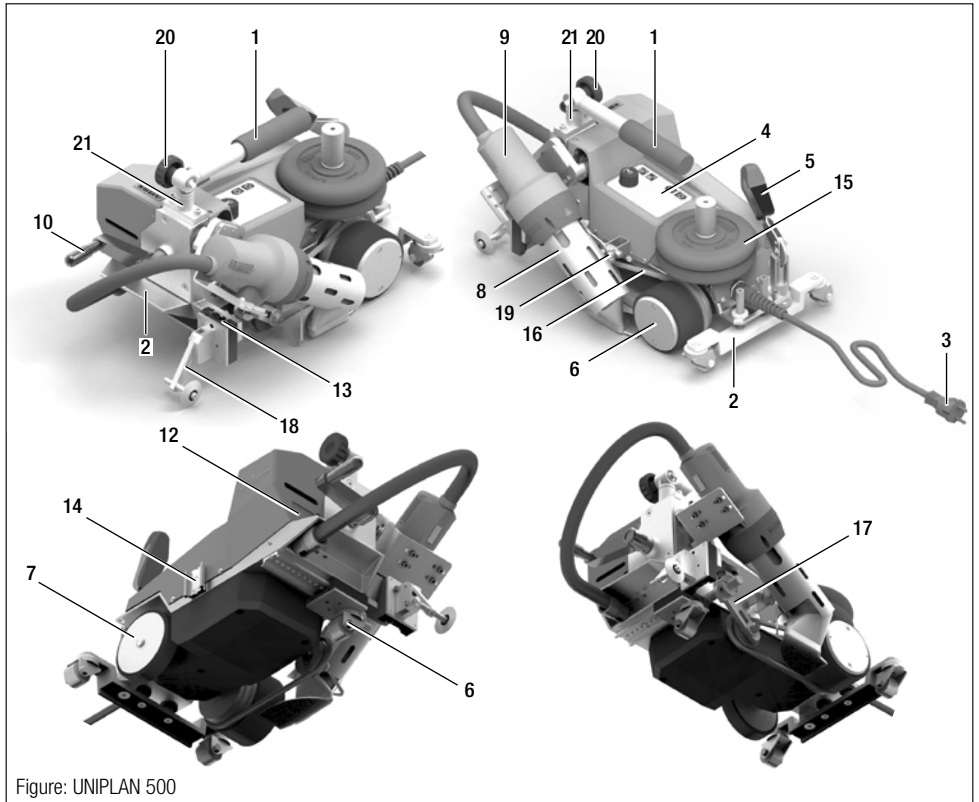

- Carrying handle / guide bar
- Handles
- Power cord
- Control panel
- Lever for automatic material lifting
- Drive roller / contact pressure roller
- Support roller
- Welding nozzle
- Hot-air blower
- Nozzle engagement lever
- Main switch

- Specification plate
- Mounting rail for accessories
- Mounting rail for accessories storage
- Auxiliary weight
- Round belt
- Tensioner for the round belt
- Overlap guide
- Material lifting device
- Lever screw
- Guide handle bracket

Power supply interruption



If the power supply fails, turn off the main switch and place the hot-air blower into the park position, in order to avoid damage to the hot-air blower.



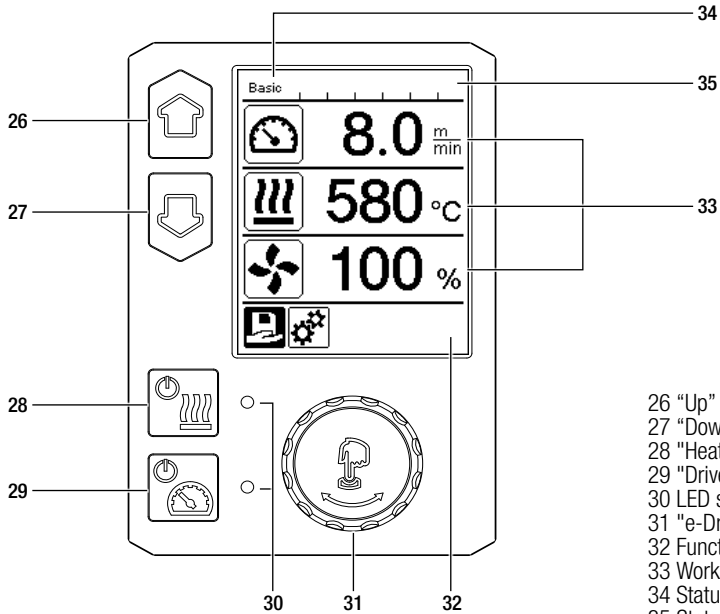

UNIPLAN 500 control panel



Overview of the UNIPLAN 500 control panel



- 26 "Up" arrow key
- 27 "Down" arrow key
- 28 "Heating on/off" key
- 29 "Drive on/off" key
- 30 LED status display
- 31 "e-Drive"
- 32 Function display
- 33 Working display
- 34 Status display "area 1"
- 35 Status display "area 2"

Function keys



Keyboard mode		Current selection Working display	Current selection function display	Current selection Setup menu
 	Up (26) Down (27)	Changes the position within the working display.	Switches from function display to working display.	Changes the position within the Setup menu.
	Heating On/Off (28)	Turns heating on/off	Turns heating on/off	No function
	Drive On/Off (29)	Turns heating on/off	Turns heating on/off	No function

	Press "e-Drive" (31)	Set value is implemented straight away and the selection jumps straight back to the function display.	Selected function is executed.	Selection of the marked position.
	Rotate "e-Drive" (31)	Setting the desired setpoints in 10 °C or 0.1 m/min increments.	Changing the position in the function display.	Changes the position within the Setup menu Setting the value of the selected position

LED status display

Heating

The LED on the **Heating "On/Off" key (28)** displays the respective condition of the heating.

LED status (30) Heating On/Off (28)	Condition	Cause
LED off	Heating is turned off.	
LED flashes green	Heating is turned on. Temperature is not at setpoint.	
LED continuously green	Heating is turned on. Temperature is at setpoint.	
LED flashes red	Warning message for heating.	 See the Chapter Warning and error messages (UNIPLAN 500) 22 [8]
LED continuously red	Error message for heating.	 See the Chapter Warning and error messages (UNIPLAN 500) 22 [8]

Drive

The LED on the **Drive "On/Off" key (29)** displays the condition of the drive.

LED status (30) Drive On/Off (29)	Condition	Cause
LED off	Drive is turned off.	
LED continuously green	Drive is turned on.	
LED continuously red	The drive has an error.	 See the Chapter Warning and error messages (UNIPLAN 500) 22 [8]

Warnings and error messages

If, during operation of the drive, a warning message occurs in the Status display "area 2" (35) or if there is an error message in the working display (33) , then this will be displayed as follows:		
Heating and drive LEDs flash green simultaneously	Error or warning	 See the Chapter Warning and error messages (UNIPLAN 500) 22 [8]

Display symbols for the UNIPLAN 500 status display

The Status display is subdivided into a left-hand and a right-hand area.

Status display "Area 1" (34) / left

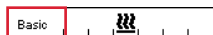

Profile name

- Displays the name of the selected currently valid welding profile (e.g. Basic).
- If a profile name contains more than six characters, the first six characters are shown first, followed by the remaining characters.

Voltage

- The current voltage is displayed alternating with the profile name.

Status display "Area 2" (35)



General Warning note

See the Chapter Warning and error messages (UNIPLAN 500) 22 [8]



Note regarding undervoltage in the power supply



Note regarding overvoltage in the power supply



Key block is activated



Heating is turned on





Display symbols of the function display











During operation, the set welding parameters (drive in m/min or ft/min, temperature in degrees Celsius or Fahrenheit, air volume in percent and, if applicable, information notes are displayed (see Application Mode: Displaying current values).

Use the **Up/Down arrow keys (26 / 27)** to switch between the welding parameters and adjust the values individually by turning the **"e-Drive" (31)**.











Display symbols for the UNIPLAN 500 working display

Symbol	Meaning
	Drive speed [m/min/ft./min]
	Air temperature [°C/°F]
	Air volume [%]
	Information box

	<p>Device is in standby mode. Once the counter setpoint has been reached the heating is turned off.</p>
	<p>An error has occurred (the device is not ready for use). Contact an authorized Service Center.</p> <p>☰ See the Chapter Warning and error messages (UNIPLAN 500) 22 [8]</p>
	<p>Warning:</p> <p>☰ See the Chapter Warning and error messages (UNIPLAN 500) 22 [8]</p>
 <p>▲ 500 °C 580</p>	<p>The arrow pointing upward and the progress bar indicate that the setpoint (shown on the progress bar) has not yet been reached (too cold). The flashing value is the actual value. The value next to the progress bar is the setpoint.</p>
 <p>▼ 565 °C 530</p>	<p>The arrow pointing downward and the progress bar indicate that the setpoint (shown on the progress bar) has not yet been reached (too hot). The flashing value is the actual value. The value next to the progress bar is the setpoint.</p>
 <p>35 °C 540</p>	<p>If “Set Values” is activated, both the actual temperature (large font) and the set temperature (small font) are displayed.</p>
 <p>580 °C</p>	<p>If “Set Values” is deactivated, during operation only the actual values (large font) are displayed, otherwise only the setpoint values (large font).</p>
	<p>Cool down mode</p>
	<p>Hardware error message, heating element faulty</p> <p>The device is no longer ready for operation. Contact an authorized Leister Service Center.</p>

Display symbols of the menu selection (Display 42)

Use the **Arrow keys (26, 27)** to select one of the available menus on the **control panel (4)**.

Symbol	Meaning	Symbol	Meaning
	Turn the drive on/off		Call up the Service menu (password-protected)
	Select a saved welding profile		Edit the current settings / current profile
	Adjust the settings		Save the current settings / current profile
	Go to the initial screen (Home)		Delete the current settings / current profile
	Go to the previous view/one level back		Initiate the cooling process
	Reset to the factory settings (Reset)		

Setup menu on the UNIPLAN 500 control panel

Setting up, saving, and selecting recipes (Save Recipes)

Your UNIPLAN 500 has more than 15 freely definable recipes and the "BASIC" recipe available. "Save Recipes" can be used to save the setpoint settings for the drive, air temperature and air flow range welding parameters under a freely selectable designation (see Input recipe names).

Creating a new recipe

Set up the desired setpoints [Working display, "**e-Drive**" (31)]

Select and confirm the "Settings" menu [Menu selection, "**e-Drive**" (31)]

Select the "Save Recipes" menu [Menu selection, "**e-Drive**" (31)]

Select and confirm the "User-defined" menu [Menu selection, "**e-Drive**" (31)]

Select and confirm the "Edit selected item" menu [Menu selection, "**e-Drive**" (31)]

Enter the desired recipe name, select Enter on the keyboard (see Inputting recipe names), and confirm [Menu selection, "**e-Drive**" (31)]

Select and confirm the "Save" menu [Menu selection, "**e-Drive**" (31)]

Your newly created recipe is now saved and can be accessed at any time under the name that has been entered.

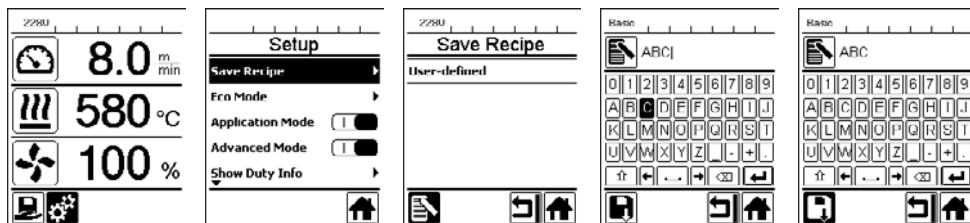

Modifying an existing recipe

Set up the desired setpoints [Working display, "e-Drive" (31)]

Select and confirm the "Settings" menu [Menu selection, "e-Drive" (31)]

Select the "Save Recipes" menu [Menu selection, "e-Drive" (31)]

Select and confirm the recipe to be adjusted [Menu selection, "e-Drive" (31)]

Select and confirm either "Save" function, "Edit selected item", or "Delete" [Menu selection, "e-Drive" (31)]

If the "Edit selected item" has been selected, enter a freely selectable recipe name in accordance with Steps 6 and 7 described above

Your newly created recipe is now saved and can be accessed at any time under the name that has been entered.

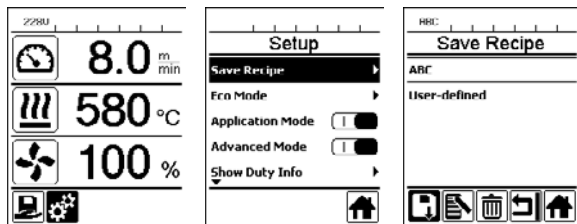



Selecting a recipe

- Choosing the "Recipes" icon in the **function display (32)** takes you to the "Select Recipes" menu.
- Use the **arrow keys (26 / 27)** to position the cursor on the desired recipe and press **"e-Drive" (31)** to confirm.
- If, during operation you change setpoints in the recipe you created, the setpoints will not be saved in the recipe. When the device is restarted, the values saved in the recipe will be displayed again.
- If you wish to apply the most recently used setpoints when you restart the device, you have to select the preprogrammed "BASIC" recipe.
- The currently selected recipe is displayed in the status display **"area 1" (34)**.

Entering recipe names

In keyboard mode, you can define names with a maximum of 12 characters.

Keyboard mode	Character selection (36)	Symbol selection (37)
	Up (26) Down (27)	Vertical character selection
	Rotate "e-Drive" (31)	Horizontal character selection
	Press "e-Drive" (31)	Horizontal symbol selection
	Confirm the selected characters	Confirm the selected symbols

	Change between upper and lower case
	Move the cursor position to enter the name
	Insert a blank space
	Delete one character (the character to the left of the cursor)
	Select this symbol to switch to the function display (32)

Basic setting and Advanced Mode



In the Basic setting, move through the Setup menu to save the recipe, to the Standby function ("Eco Mode") and Advanced Mode.

Additional information and setting options are available in Advanced Mode.

Operating readiness (Eco Mode)



If the motor is turned off, the heating is activated, and if no key is pressed during the time defined under "Eco Mode" interval, then the device will switch over automatically to the Standby display. If the **"e-Drive" (31)** is not pressed during the subsequent 180 seconds, then the heating will switch to Cool Down mode. Standby will then appear on the display. Pressing **"e-Drive" (31)** causes the device to switch to Working mode.

Standby mode is not activated when the devices are shipped.

The desired time interval can be defined individually by selecting the Eco Mode menu with the **"e-Drive" (31)** and then setting the desired value with the **"e-Drive" (31)**.

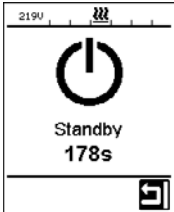
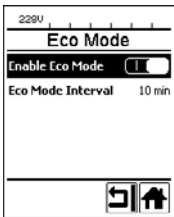

Duty Info (only in Advanced Mode)

Under Duty Info you will find information regarding the runtime of your UNIPLAN 500.

Use the "e-Drive" (31) to access the "Settings" menu and confirm your selection. Now use the "e-Drive" (31) to set the "Advanced Mode" to "On" and then select "Duty Info".

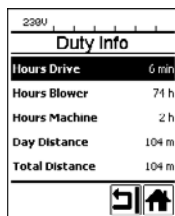

Duty Info	
Hours Drive	6 min
Hours Blower	74 h
Hours Machine	2 h
Day Distance	104 m
Total Distance	104 m

Drive hours: Current runtime of the drive

Blower hours: Current runtime of the blower

Machine hours: Current runtime of the machine

Day distance: Distance covered since last reset (must be reset manually)

Total Distance: Distance covered since commissioning of the device

General Info (only in Advanced Mode)



General Info	
Firmware HMI	V2.04
Firmware Machine	V0.03
Production Year	2018
Production Month	1
Production Day	1

Under "General Info" you will find version information regarding the software in addition to information regarding the date of production.

Use the "e-Drive" (31) to access the "Settings" menu and confirm your selection. Use the "e-Drive" (31) to set the "Advanced Mode" to "On" and then select "General Info".

Warnings (only in Advanced Mode)

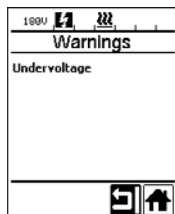

Warnings	
Undervoltage	

Warnings are displayed as they arise in the **status display area 2 (35)**. The "Warnings" menu indicates which malfunction has occurred. Once the malfunction has been rectified, the entry disappears.

Use the "e-Drive" (31) to access the "Settings" menu and confirm your selection. Use the "e-Drive" (31) to set the "Advanced Mode" to "On" and then select Warnings.

Machine Setup (only in Advanced Mode)



Machine Setup	
Select Unit (Metric / Imperial)	metric
LCD Contrast	0
LCD Backlight	90 %
Key Backlight	50 %

Use the "e-Drive" (31) to access the "Settings" menu and confirm your selection. Use the "e-Drive" (31) to set the "Advanced Mode" to "On" and then select "Machine Setup".

Unit: Setting the system's units (metric or imperial) for Unit Speed and Unit Heat.

LCD Contrast: Adjusting the LCD display contrast

LCD Backlight: Adjusting the LCD display background illumination

Key Backlight: Adjusting the keyboard's background illumination on the **control panel (4)**

Displaying current values – Application Mode (only in Advanced Mode)



If you wish to have an overview of relevant information, e.g., supply voltage, capacity utilization of the heating, select the "Settings" menu and confirm your selection. Now activate the "Application Mode".

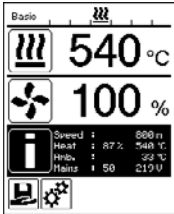

All available information (symbol i) is now displayed in the **working display (33)** (see Display symbols on the working display).

Set Values (only in Advanced Mode)

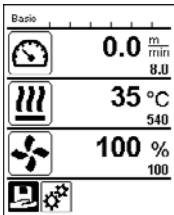

If you have activated the "Set Values" function, then the actual values are shown in large font and the setpoint values are shown in small font in the **working display (33)**. This applies to both speed and temperature. If the function has been deactivated, only the setpoint values are displayed.

The "Set Values" function is deactivated by the factory.

Reset to defaults (only in Advanced Mode)



Use the "**e-Drive**" (31) to access the "Settings" menu and confirm your selection. Now set the "Advanced Mode" to "On" and then select "Reset to defaults".

This function can be used to reset all of the individually set values back to the factory settings. The reset affects not only the settings, (Setup) but also the recipes. Confirm your selection with the button on the lower left (Reset to factory settings/Reset).

Day distance display

As soon as the drive is running, the distance is displayed. The day distance can be retrieved as follows:

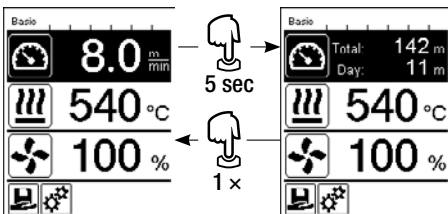

Use the "**Up**" (26) and "**Down**" (27) arrow keys to position the cursor on the speed in the **working display (33)**. Hold the "**e-Drive**" (31) down for five seconds.

The values of the day distance and the total distance are now shown in the speed display.

Briefly pressing on the "**e-Drive**" (31) causes the speed to be shown again in the **working display (33)**.

Resetting the day distance

The day distance can be reset only once the drive is switched off.

Duty Info	
Hours Drive	10 min
Hours Blower	74 h
Hours Machine	3 h
Day Distance	11 m
Total Distance	142 m

Duty Info	
Hours Drive	10 min
Hours Blower	74 h
Hours Machine	3 h
Day Distance	11 m
Total Distance	142 m

Select the "Day Distance" line in the "Duty Info" (see the Chapter Duty Info 15 [6.5]).

The cursor will then automatically highlight the "Reset hours counter" icon. Use the "e-Drive" (31) to confirm.

The hour counter is then reset.

Key lock

The UNIPLAN 500 has a key lock. This blocks the four keys and the "e-Drive" (31) on the control panel (4). The key lock is activated or deactivated by simultaneously pressing the "Up" and "Down" arrow keys (26/27) for at least 2 seconds. When the key lock is activated, this is indicated on the status bar.

Status Bar	
	8.0 $\frac{m}{min}$
	540 °C
	100 %

Commissioning the UNIPLAN 500

Operating readiness

Prior to commissioning, check the power cord (3), the plug, and the extension cable for electrical and mechanical damage. Damaged plugs and the extension cables must not be used, there is a risk of an electric shock. If you are using the hot-air welder on a table, take care at all times to prevent the welder falling off the table. If you are working on the ground and the operation will be prolonged, for ergonomic reasons we recommend the use of a long guide rod. This is available in the accessories set.

Adjusting the welding nozzle (8)

- The basic setting of the welding nozzle (8) is performed in the works.
- Check the basic setting of the welding nozzle (8).

The setting can be checked by the nozzle gauge (24) or as by the measurements A and B.

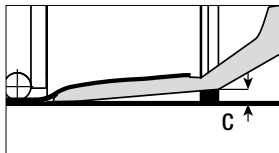
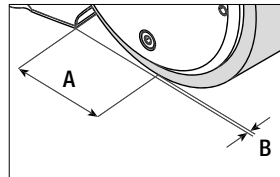
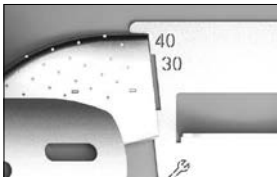

$$\begin{aligned} A &= 45 \pm 5 \text{ mm} \\ B &= 1 - 2 \text{ mm} \\ C &= 1 \text{ mm} \end{aligned}$$

Installing the guide bar (1)

- Install the **guide bar (1)** using the **lever screw (20)** and set it to the desired position

Adding an auxiliary weight (15)

- Install the **weight holder base (22)**, plus any necessary **weight holder extensions (23)**, and place the **weights (15)** on the weight holders (max. seven auxiliary weights)

Adjusting the overlap guide (18)

The roller on the **overlap guide (18)** has 4 markings

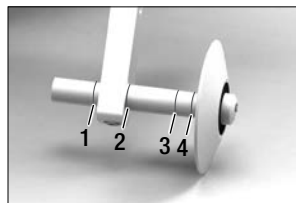

- 1: Not used
- 2: Marking 40, 30, 20 mm overlap (factory setting)
- 3: Not used
- 4: Marking tape 40 mm

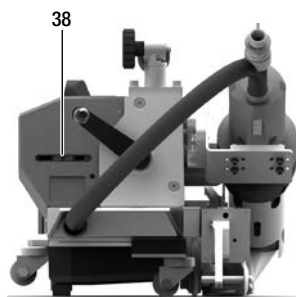

Adjusting the starting switch

Release the **starting switch (38)** clamp, and move the starting switch as required. Moving it to the left increases the starting delay, moving it to the right reduces the starting delay. This increases or reduces the preheating time at the start up.

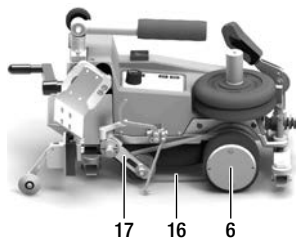

Adjusting the round belt (16)

Check the position of the **round belt (16)**. The **round belt (16)** must lie parallel to the **drive roller / contact pressure roller (6)**. If necessary, adjust the **tensioner (17)** for the round belt.

Starting the device



Connect the device to an **outlet with a protective conductor**. Any interruption of the protective conductor inside or outside of the device is not permitted. Only use extension cables with protective conductors.



The local supply voltage must match the nominal voltage specified on the device. EN 6100-3-11; UNIPLAN 500 $Z_{max} = 0.384\Omega + j 0.240\Omega$; UNIPLAN 300 $Z_{max} = 0.377\Omega + j 0.236\Omega$. If necessary, consult supply authority. If the power supply fails, turn off the **main switch (11)** and place the **hot-air blower (9)** into the park position, in order to avoid damage.



If the device is being used on job sites, a residual-current circuit breaker must be used to protect site personnel.



Place the **hot-air blower (9)** into the park position and connect the hot-air welder to the power supply.

Use the **main switch (11)** to turn the hot-air welder on.

After starting, the Start screen will appear briefly in the display with the version number of the current Software Release and the device designation.

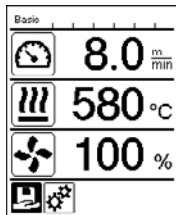

After the device has cooled down, a static display of setpoints from the most recently used profile (the Profile Basic is displayed at the time of initial commissioning of the device).

At this stage, the heating is not yet turned on!

Select the desired welding profile or define the welding parameters individually (see "Setting the parameters").

Now turn on the heating (**Heating on/off, 28**).

Then perform test welds in accordance with the welding instructions of the material manufacturer and/or national standards or regulations, and inspect the results. Adjust the welding profile as necessary.

Setting the welding parameters

With the UNIPLAN 500 you can regulate the setpoints of the three welding parameters individually at any time, even during ongoing operations.

Proceed as follows:



Select:

Use the **arrow keys (26 / 27)** to select the parameter to be changed.

Representation:

The selected area is shown with a dark background.

Adjustment:

Rotate the **"e-Drive" (31)** to adjust the selected setpoint to your requirements.

Welding sequence

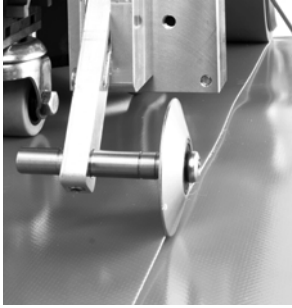

Positioning the device

- Check that the upper and lower sides of the material to be welded are clean between the edges of the overlap.
- Then check that the **welding nozzle (8)**, the **drive roller / contact pressure roller (6)** and the **round belt (16)** are clean.
- Now use the **material lifting device (5)** to lift the hot-air welder and move the device to the desired welding position.
- Then put down the roller on the **overlap guide (18)**.
- Make sure that the roller on the **overlap guide (18)** is in line with the outer edge of the **contact pressure roller (6)**.

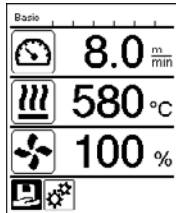

Welding Preparation

- As soon as you have turned on the heater, you will see a dynamic display of the current air temperature with progress bar (setpoint and actual values).
- Make sure that the tool has reached the appropriate welding temperature before commencing work (the heat-up time is three – five minutes).
- Now use the **material lifting device (5)** to lower the hot-air welder into the working position.
- Slightly lift the material behind the automatic welder and pull the material lifting device lever (19) towards the hot-air blower until the material rests against the lever. This ensures that the nozzle can be inserted between the two pieces of material.
-



Commencing welding

- Press the **lever to engage the nozzle (10)**; the **hot-air blower (9)** is lowered automatically and the welding nozzle is inserted between the two pieces of material.
- The **material lifting device (19)** is automatically activated when the nozzle is engaged and triggers the lever.
- The drive motor automatically starts as soon as the hot-air blower (9) is engaged.

You can also start the device manually with the **Drive On/Off key (29)**.

Guiding the device during the welding process

Use the **guide bar (1)** or the machine housing to guide the hot-air welder along the overlap, constantly monitoring the position of the **overlap guide roller (18)**.

When welding with the hot-air welder, do not force the welder along the seam, lest this causes welding defects.

Check the parameters while welding is in progress

Welding speed, air temperature and air flow range are monitored continuously.

If an actual value deviates from a setpoint of the welding profile or the individual settings, this is shown in the **working display (33)**.

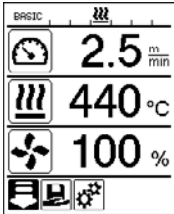

Actual value corresponds to the setpoint.

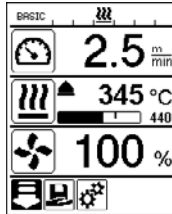

The air temperature's actual value is lower than the setpoint.

The heating up process is signaled by flashing; the arrow points upwards, the progress bar visualizes the temperature relative to the setpoint temperature value.

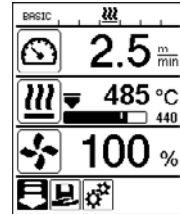

The air temperature's actual value is higher than the setpoint.

The cooling-down procedure is signaled by flashing; the arrow points downwards, the progress bar visualizes the temperature relative to the setpoint temperature value.

Welding completion

On completion of the weld, disengage the nozzle using the **lever (10)** to the stop. This retracts the **hot-air blower (9)** and stops the drive.

Then swing the **overlap guide roller (18)** upwards and use the **lifting device (5)** to lift the hot-air welder up.

Turning off the device



- Use the **Heating on/off key (28)** to turn off the heating.
- The text "Heating off?" appears on the display. After the "e-Drive" key has been pressed, the device switches into cool-down mode (see Cool-Down Mode).
- The blower switches off automatically after approx. five minutes.
- Now turn off the device with the **main switch (11)** and disconnect the **power supply cord (3)** from the electrical network.

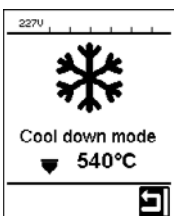





- Wait until the device has cooled down.
- Check the **power cord (3)** and plug for electrical and/or mechanical damage. Damaged plugs and extension cables must not be used due to risk of an electric shock.
- Use a brass wire brush to clean the **welding nozzle (8)**.

Warning and error messages (UNIPLAN 500)

Warning and error messages are displayed as they arise in the **status display (34)** or in the **working display (33)**. If a warning message is active you may still be able to continue to work.

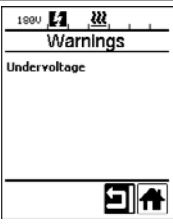
If an error message is active you cannot continue to work. The heating is turned off automatically, the blower is switched on, and the drive is blocked. The corresponding error code is immediately shown in the **working display (33)**.

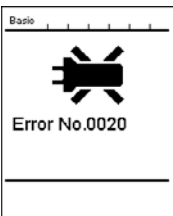
Concrete information regarding the type of error or the warning can be called up at any time using the "Warnings" item in the "Settings" menu.

Type of message	Display	Error code/ Warning message	Description
Warning		Ambient temperature	Ambient temperature is too high
		Undervoltage	Supply voltage is too low
		Overvoltage	Supply voltage is too high
Error		0001	Device has overheated Solution: Let the device cool down
		0020	Heating element is faulty Solution: Replace the heating element
Error (contact Leister Service Center)		0002	Overvoltage or undervoltage of the power supply
		0004	Hardware error
		0008	Thermocouple is defective
		0080	Automatic control unit error
		0100	Blower motor error
		0200	Communication module error
		0400	Drive error

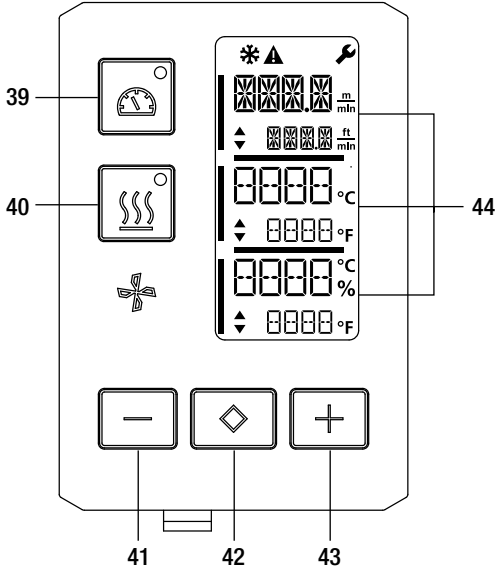

UNIPLAN 300 control panel

Overview of the UNIPLAN 500 control panel



- 39. Drive "On/Off" key with LED status display
 - 40. Heating "On/Off" key with LED status display
 - 41. Minus key
 - 42. Confirm button
 - 43. Plus key
 - 44. Display fields
- The actual values are displayed in large font and the setpoint values in small font. The cursor is located on the left-hand side and the parameter unit on the right-hand side.

Symbols

Symbol	Meaning
	Cool down mode Symbol for the cool-down process
	Warning message and error message See the Chapter Warning and error messages (UNIPLAN 300) 28 [11]
	Maintenance See the Chapter Maintenance (UNIPLAN 300) 28 [12]

LED status display

Heating

The LED display on the **Heating "On/Off" key (40)** shows the respective condition of the heating.

LED status Heating On/Off (40)	Condition
LED off	Heating is turned off.
LED flashes green	Heating is turned on. Temperature is outside the tolerance range.
LED continuously green	Heating is turned on. Temperature is within the tolerance range.

Drive

The LED display on the **Drive "On/Off" key (39)** shows the condition of the drive.

LED status Drive On/Off (37)	Condition
LED display off	Drive is turned off
LED display continuously green	Drive is turned on

Heating and drive

If the two LED displays for the **Heating "On/Off" (40) key** and the **Drive "On/Off" (39) key** flash simultaneously, an error is active (see Chapter Warning messages and error messages (UNIPLAN 300) 28 [11]).

Setting the parameter units

The units for the welding speed and for the temperature can be adjusted.

Temperature: °C or °F

Speed: $\frac{\text{m}}{\text{min}}$ or $\frac{\text{ft}}{\text{min}}$

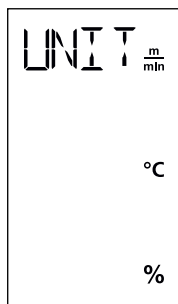

Hold down the **Drive "On/Off" (39)** and **Heating "On/Off" (40)** keys and turn on the device using the **main switch (11)**. "UNIT" then appears on the display.

Press the **Confirm key (42)** to confirm and use the **Plus/Minus keys (41/43)** to set the desired units.

Press the **Confirm key (42)** to confirm and use the **Plus key (41)** to select "SAVE". Press the **Confirm key (42)** to confirm; the units are then saved.

The device then restarts automatically.

Commissioning the UNIPLAN 300

Operating readiness

Prior to commissioning, check the **power cord (3)**, the plug, and the extension cable for electrical and mechanical damage. Damaged plugs and the extension cables must not be used, due to risk of an electric shock. If you are using the hot-air welder on a table, take care at all times to prevent the welder from falling off the table.

If the operation will be prolonged, we recommend the use of a guide handle. The accessories set contains a short guide handle (working on a table) and a long guide handle (working on the ground).

Adjusting the welding nozzle (8)

See Chapter 7.1

Adjusting the overlap guide (18)

See Chapter 7.1

Adjusting the starting switch

See Chapter 7.1

Adjusting the round belt (16)

See Chapter 7.1

Starting the device

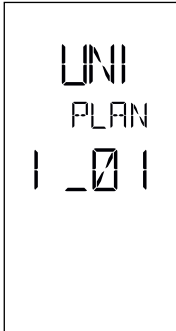

- Once you have prepared the working area and the hot air welder in accordance with the description, use the **main switch (11)** to turn the hot-air welder on.
- After starting, the Start screen will appear briefly in the display with the version number of the current software release and the device designation.
- If the device had cooled down beforehand, this will be followed by a static display of the setpoints
- **At this stage, the heating is not yet turned on**

Setting the welding parameters



Connect the device to a **socket with a protective conductor**. Any interruption of the protective conductor inside or outside of the device is not permitted. Only use extension cables with protective conductors.



The local supply voltage must match the nominal voltage specified on the device. EN 6100-3-11; UNIPLAN 500 $Z_{max} = 0.384\Omega + j 0.240\Omega$; UNIPLAN 300 $Z_{max} = 0.377\Omega + j 0.236\Omega$. If necessary, consult supply authority. If the power supply fails, turn off the **main switch (11)** and place the **hot-air blower (9)** into the park position, in order to avoid damage.



If the device is being used on job sites, a residual-current circuit breaker must be used to protect site personnel.

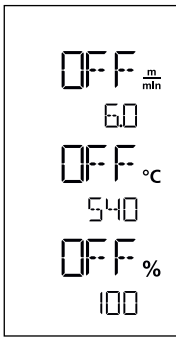

If the drive is switched off, then the welding parameters for temperature, air volume, and speed are set as follows in the **display fields (44)**:

Using the **Confirm key (42)**, you can move the cursor to the desired parameter. Use the **Plus / Minus keys (41/43)** to set the value of the selected parameter.

When the drive is switched on, the welding parameters are set in the same way and transferred immediately. The cursor automatically switches back to the drive speed row 5 seconds after the entry has been made.

Welding sequence

Welding preparation

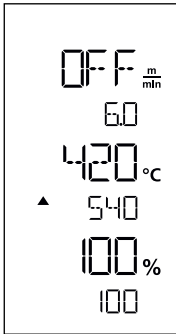

- As soon as you have turned on the heating, you will see a dynamic display of the current air temperature (setpoints and actual values).
- Make sure that the welding temperature has been reached before commencing work (the heat-up time is three – five minutes).
- Slightly fold the top piece of material behind the contact pressure roller. This ensures that the nozzle can be inserted between the two pieces of material.

Commencing welding

- Rotate the lever to engage the **nozzle (10)**; the **hot-air blower (9)** is lowered automatically and the welding nozzle is inserted between the two pieces of material.
- The drive motor automatically starts as soon as the **hot-air blower (9)** is engaged.

You can also start the device manually with the **Drive "On/Off" key (39)**.

Guiding the device during the welding process

Use the **housing** to guide the hot-air welder along the overlap, constantly monitoring the position of the **overlap guide roller (18)**.

When welding with the hot-air welder, do not force the welder along the seam, lest this causes welding defects.

Check the parameters whilst welding is in progress

Welding speed, air temperature and air flow range are monitored continuously. If an actual value deviates from the selected settings, this will be shown in the **Work display (44)**.

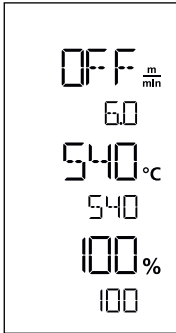

Actual value corresponds to the setpoint.

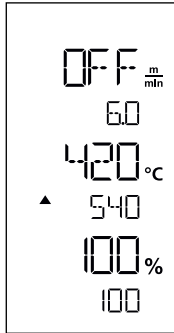

The air temperature actual value is lower than the setpoint. The heat-up process is signaled by flashing; the arrow is pointing upwards.

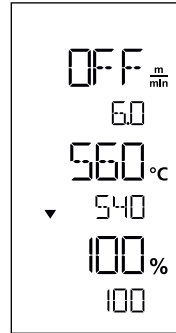

The air temperature actual value is higher than the setpoint. The cool-down process is signaled by flashing; the arrow is pointing downwards.

Finishing welding

Once welding has been completed, remove the nozzle, using the **lever (10)**. This will retract the **hot-air blower (9)** and stop the drive.

Then place the **overlap guide roller (18)** in the upwards position and use the **lifting device (5)** to remove the hot-air welder from the ground.

Turning off the device



Use the **heating on/off key (40)** to turn off the heating. The device switches to cool down mode and the blower switches off automatically after approx. five minutes.

Now turn off the device with the **main switch (11)** and disconnect the **power supply cord (3)** from the electrical network.



- Wait until the device has cooled down.
- Check the **power cord (3)** and plug for electrical and/or mechanical damage. Damaged plugs and the extension cables must not be used, due to risk of an electric shock.
- Use a brass wire brush to clean the **welding nozzle (8)**.

Warning and error messages, UNIPLAN 300

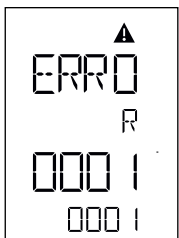
Type of message	Display	Error code / Warning message	Description
Error		0001	Device has overheated Solution: Let the device cool down
		0004	Hardware error
		0008	Thermocouple is defective
		0400	Drive error

Maintenance of the UNIPLAN 300



When the maintenance interval for the device is reached, the start display will show "BLOWER" or "DRIVE". The display disappears automatically after 10 seconds, or can be acknowledged by pressing **Confirm key (42)**. You must take the device to your service center.



Frequently asked questions

The machine turns on automatically after the blowers have been turned on:

- If the air temperature is more than 100°C when the device is turned on, the device switches automatically to Cool-Down mode. The cool-down process is finished when the air temperature is less than 100°C for 2 minutes.

The machine turns off automatically:

- In Standby mode, the heating is switched off automatically after the time elapses that the user has stored (see also Standby mode). This feature is available only on the UNIPLAN 500.

Deficient welding result quality:

- Check drive speed, welding temperature and air flow range.
- Clean the **welding nozzle (9)** with wire brush (see Maintenance).
- **Welding nozzle (9)** incorrectly adjusted (see Adjust welding nozzle).

If the set welding temperature has not been reached after five minutes:

- Check the supply voltage
- Reduce the air volume

Changing the weld width:

- Please contact your local distributor for further information on changing the weld width.

Other applicable documents

- Safety Instructions – Automatic Welders/Extrusion Welders/Welding Machines (Article number: 129.102)



PLASTIC WELDING PRODUCTS | INDUSTRIAL HEATING & LASER SYSTEMS

Leister Technologies AG | Galileo-Strasse 10 | 6056 Kägiswil | Switzerland
phone: +41 41 662 74 74 | leister@leister.com | www.leister.com | www.weldy.com

EU declaration of conformity

(in terms of the EC machinery directive 2006/42/EC; Appendix II A)

Leister Technologies AG

Galileo-Strasse 10, CH-6056 Kaegiswil/Switzerland

as manufacturer hereby declares that the product

Designation: Hot Air Welder

Type: UNIPLAN 300, UNIPLAN 500

is in conformity with the provisions of the following EU directives:

EU directives	2006/42/EC	(Machinery Directive)
	2014/30/EU	(EMC Directive)
	2011/65/EU	(RoHS Directive)

The following harmonised standards have been applied:

Harmonised standards	EN ISO 12100:2010
	EN 55014-1:2017
	EN 55014-2:2015
	EN 61000-3-2:2014
	EN 61000-3-3:2013
	EN 61000-6-2:2005
	EN 62233:2008
	EN 60335-1:2012 + A11:2014 + A13:2017
	EN 60335-2-45:2002 + A1:2008 + A2:2012
	EN 50581:2012

Authorised documentation representative: Thomas Schäfer, Manager Product Conformity

Kaegiswil, 02.07.2019

Bruno von Wyl
(Chief Technical Officer)

Christoph Baumgartner
(General Manager)

Warranty

- The guarantee or warranty rights granted for this device by the direct distribution partner/salesperson apply from the date of purchase. In the event of a guarantee or warranty claim (verification by invoice or delivery note), manufacturing or processing errors will be rectified by the sales partner through replacement delivery or repair. Heating elements are excluded from warranty obligations or guarantees.
- Other guarantee or warranty claims are excluded within the framework of mandatory law.
- Damage resulting from natural wear, overload, or improper handling is excluded from the warranty.
- No guarantee or warranty claims exist for devices that have been converted or modified by the purchaser.

↳ Sales and service center

Leister Technologies AG
Galileo-Strasse 10
CH-6056 Kaegiswil/Switzerland
Tel. +41 41 662 74 74
Fax +41 41 662 74 16
www.leister.com
sales@leister.com